

### SPECIFICATIONS

#### RECOMMENDED USE

Domestic

#### COLOUR AVAILABILITY



#### PRESSURE RATING

Recommended minimum working pressure 150kPa  
Recommended maximum working pressure 500kPa  
Hot and cold water inlet pressure should be equal

#### TEMPERATURE RATING

Maximum continuous working temperature 75°C  
If the water temperature exceeds 75°C, an approved tempering valve must be fitted

#### SUITABLE HOT WATER UNITS

Storage tank: Yes  
Continuous Flow: Yes  
Gravity Feed: Not suitable

#### WARRANTY

Structure: 25 years | Finish: 5 years | Cartridge: 10 years

Disclaimer: Products in this specification manual must by regulation be installed by licensed and registered trade people. The manufacturer/distributor reserves the right to vary specifications or delete models from their range without prior notification. Dimensions are nominal measurements only. Dimensions and set-outs listed are correct at time of publication however the manufacturer/distributor takes no responsibility for printing errors. All ABI Products are designed in Australia. Copyright ABI Interiors 2019. WWW.ABIINTERIORS.COM.AU

### INSTALLATION MANUAL

#### PLEASE READ BEFORE INSTALLING

FLOW RESTRICTOR TO BE INSTALLED WHEN USING THIS PRODUCT OVER A BASIN AND PAIRED WITH A SPOUT. FLOW RESTRICTORS ARE PROVIDED WITH THE SPOUT.

This product must be installed by a qualified plumber.

- 1 Fasten screws to secure the shower mixer assembly in place.



- 2 Attach water supply and water outlet. TEST AND CHECK FOR LEAKS

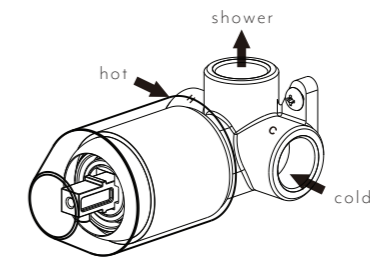

- 3 Create a 45mm round hole in cement sheet and tiles

Remove the protective cover. Push the dress plate over the shower mixer assembly gently.

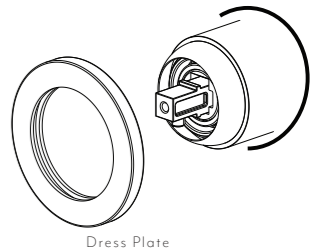

- 4 Assemble the plate and fix it in place.

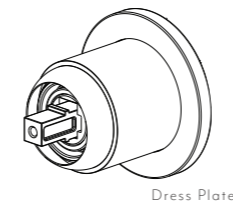

- 5 Push in the rubber gasket to mixer handle. Fasten the grub screw firmly with the allen key

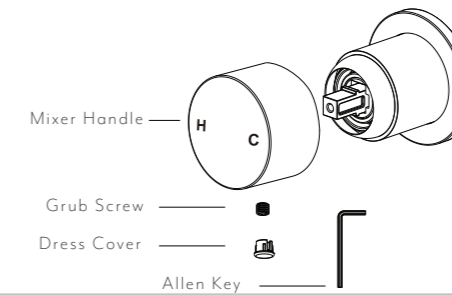

#### PROGRESSIVE MIXER OPERATION

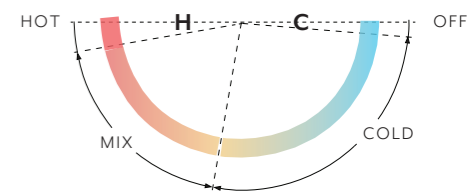

#### EXPLODED VIEW

- Item Description Code
- 1-2 Body
  - 3 Back Plate
  - 4 O-Ring
  - 5 Cartridge
  - 6 Locking Nut
  - 7 Sleeve
  - 8 Dome
  - 9 Handle
  - 10 Grub Screw
  - 11 Cap
  - 12 Fixing Screws
  - 13 Protective Case
  - 14 Allen Key

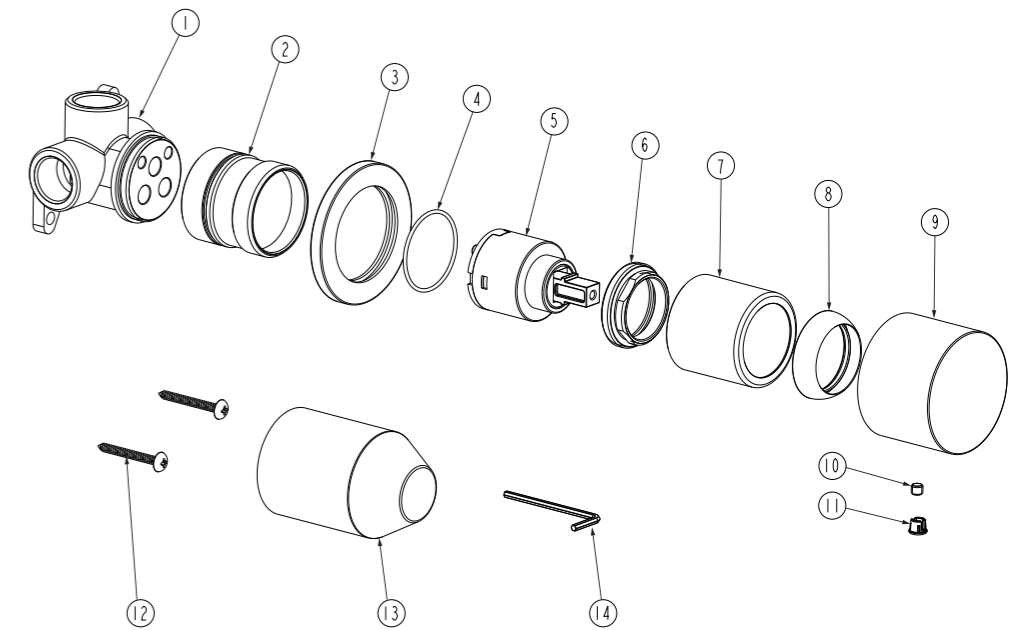

Regularly clean with mild liquid detergent or soap and water



DO NOT use cream cleaners or bleach. These substances are abrasive

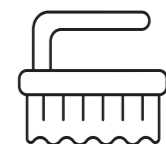

DO NOT use cleaning pads with abrasive surfaces as this may scratch the material